

WALK-IN REPLACEMENT DOOR ORDER FORM

JOB INFORMATION



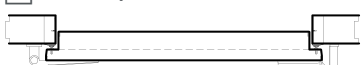

FIRST & LAST NAME:		JOB NAME:	
JOB ADDRESS:			

DETAILS OF YOUR EXISTING DOOR

For measurement guide reference and correlating letters of the ones below, please see guide on second page.

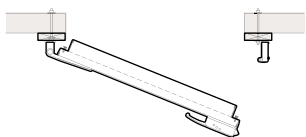
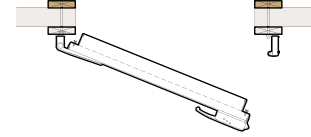
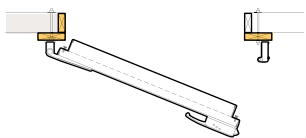
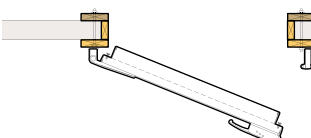
<input type="checkbox"/> FLUSH-MOUNT DOOR 	PROVIDE THE NARROWEST DIMENSIONS FOR THE WIDTH & HEIGHT OF DOOR OPENING:		
	(A) - WIDTH:		(B) - HEIGHT:
For Flush Mount Door, step inside the box, turn around, and measure the inside dimensions of the door opening as highlighted in yellow on the graphic to the left.			
<input type="checkbox"/> OFFSET/INSET DOOR 	(C) - EXISTING RAISED INSULATED FLOOR:		
	<input type="checkbox"/> N/A	<input type="checkbox"/> YES (FLOOR THICKNESS)	
EXISTING RAMP:		<input type="checkbox"/> INTERIOR RAMP	<input type="checkbox"/> EXTERIOR RAMP
IS IT A COOLER OR A FREEZER?		(D) - LEFT OR RIGHT HINGE?	
<input type="checkbox"/> COOLER	<input type="checkbox"/> FREEZER	<input type="checkbox"/> LEFT HINGE	<input type="checkbox"/> RIGHT HINGE
(E) - MEASURE THE EXISTING WALL THICKNESS:			
ARE THERE ANY OBSTRUCTIONS WITHIN 8" OF THE DOOR OPENING? IF YES, CHECK ALL THAT APPLY.		<input type="checkbox"/> DOOR VENT	<input type="checkbox"/> LIGHT SWITCH
		<input type="checkbox"/> THERMOSTAT	

CHOOSE FROM FOUR REPLACEMENT DOOR KIT OPTIONS

FACE FRAME DOORS:			
	<input type="checkbox"/> DOOR WITH EXTERIOR FACE FRAME		<input type="checkbox"/> DOOR WITH EXTERIOR FACE FRAME & BACK JAMB
	<input type="checkbox"/> EXTERIOR FACE FRAME ONLY (No door)		<input type="checkbox"/> EXTERIOR FACE FRAME & BACK JAMB ONLY (No door)
L-SHAPED FACE FRAME DOORS:			
	<input type="checkbox"/> DOOR WITH EXTERIOR FACE FRAME		<input type="checkbox"/> DOOR WITH EXTERIOR FACE FRAME & BACK JAMB
	<input type="checkbox"/> EXTERIOR FACE FRAME ONLY (No door)		<input type="checkbox"/> EXTERIOR FACE FRAME & BACK JAMB ONLY (No door)
 WALL	 EXTERIOR FACE FRAME	 BACK JAMB	 L-SHAPE FRAME

SELECT FINISHES & ACCESSORIES

VIEWPORT WINDOW:	<input type="checkbox"/> N/A	<input type="checkbox"/> YES (14" X 14")	<input type="checkbox"/> YES (14" X 24")	<input type="checkbox"/> WITH HEAT
KICKPLATES:	<input type="checkbox"/> INTERIOR	<input type="checkbox"/> EXTERIOR		
HEIGHT:			FINISH:	<input type="checkbox"/> ADT <input type="checkbox"/> 16 GA. STAINLESS STEEL
DOOR FINISHES:				
INTERIOR:	<input type="checkbox"/> WHITE	<input type="checkbox"/> GALVANIZED (GRAY)	<input type="checkbox"/> STAINLESS STEEL	<input type="checkbox"/> OTHER
EXTERIOR:	<input type="checkbox"/> WHITE	<input type="checkbox"/> GALVANIZED (GRAY)	<input type="checkbox"/> STAINLESS STEEL	<input type="checkbox"/> OTHER
REPLACEMENT PARTS:	<input type="checkbox"/> THRESHOLD	<input type="checkbox"/> THERMOMETER	<input type="checkbox"/> 3-WAY LIGHT SWITCH WITH PILOT	
<input type="checkbox"/> JAMB GUARDS	<input type="checkbox"/> OTHER			

HOW TO MEASURE FOR REPLACEMENT WALK-IN DOORS

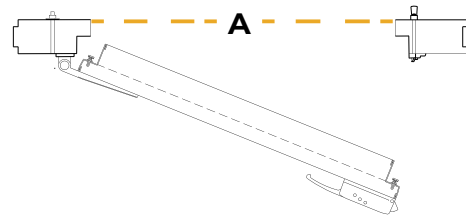
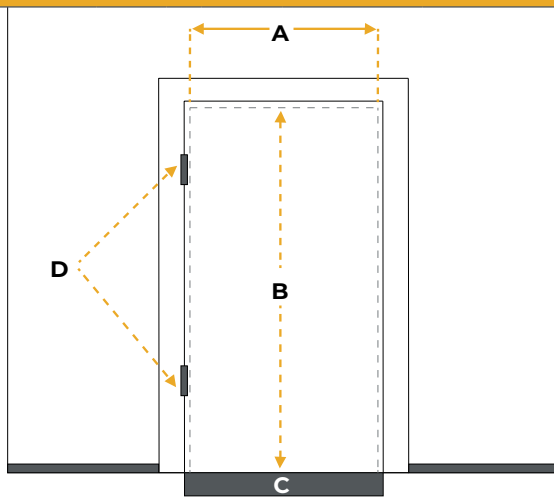

(A) - DOOR OPENING WIDTH

Supply measurements for the narrowest dimension for the width of the door opening. Do **NOT** include door frame in measurements.

For Flush Mount Door, stand inside the box, turn around, and measure the inside width of the opening. Do **NOT** include door frame.

(B) - DOOR OPENING HEIGHT

Stand inside the door and only measure the inside door height. Do **NOT** include door frame in measurements.

(C) - EXISTING RAMP

(D) - DOOR HINGES

Specify if the door hinges are on the left or right side of the door.

(E) - WALL THICKNESS

Supply measurements for the thickness of the existing wall. Do **NOT** include the thickness of the door frame.

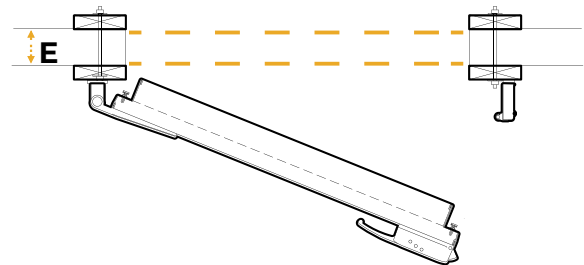

NOTE

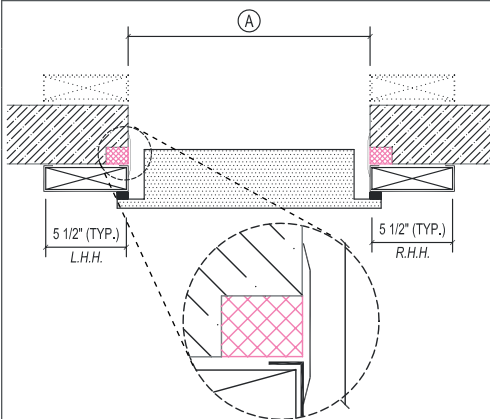

Everidge supplies trim metal. Installer needs to place rigid insulation in existing flush mount void and place trim metal over insulation.

HOW TO ORDER

Save, scan, or take a photo of your quote request/order form and email it to us at doors@everidge.com. Include your contact information and we will confirm pricing and approximate lead time for shipping. Normal lead time is 10 to 15 working days. All freight is FOB. Freight costs will be added to your quote/invoice.

Please Note: Customer is responsible for verifying all dimensions before ordering door.